

# **Lightguide with Butterfly Eye-Pupil Expander based on Patent by Microsoft**

# Abstract

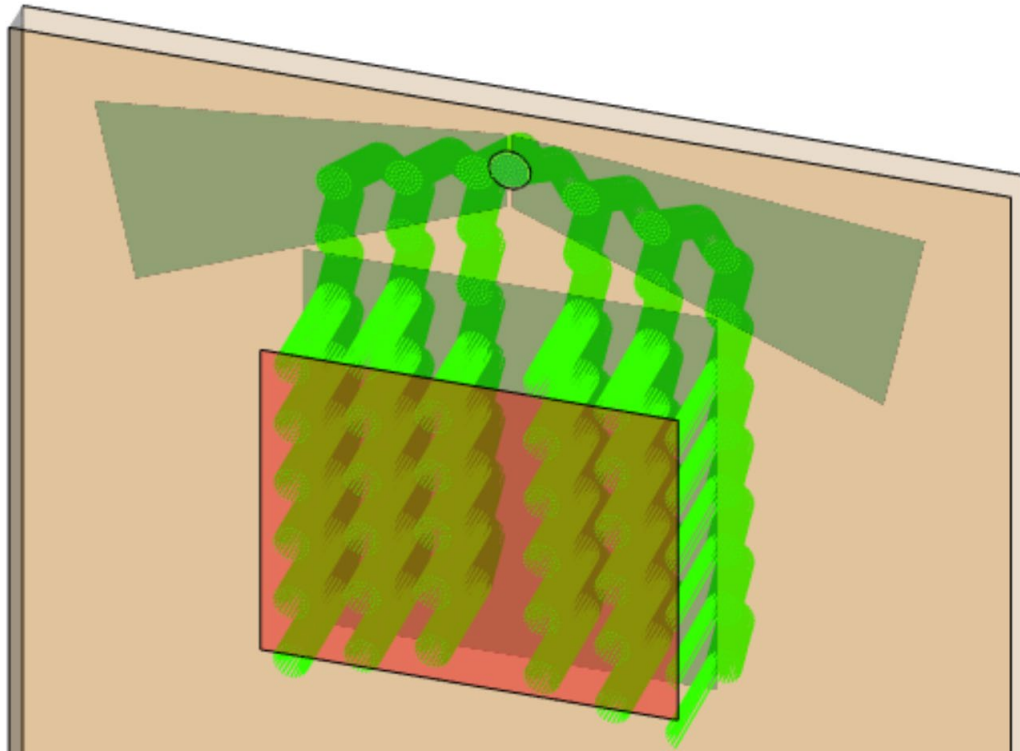

In the process of the design of lightguide devices for augmented and mixed reality (AR&MR) applications, parameters like the provided Field of View (FOV) are of major interest. In order to push the limits of the maximum FOV achievable, various approaches have been investigated, such as systems that split the FOV during the propagation from incoupler to outcoupler. One very popular approach is the so-called “butterfly pupil expansion”, where two separate EPE grating regions are used for the positive and negative parts of the FOV, and which is also applied in Microsoft’s HoloLens 2. In this document, we show the realization of such an EPE concept in VirtualLab Fusion, based on patent US9791703B1 by Microsoft.

# Modeling Task: Approach from Patent US9791703B1



US009791703B1

(12) **United States Patent**  
Vallius et al.

(10) **Patent No.:** US 9,791,703 B1  
(45) **Date of Patent:** Oct. 17, 2017

(54) **WAVEGUIDES WITH EXTENDED FIELD OF VIEW**

FOREIGN PATENT DOCUMENTS

(71) Applicant: **MICROSOFT TECHNOLOGY LICENSING, LLC**, Redmond, WA (US)

CN 104035157 A 9/2014  
CN 104280885 A 1/2015  
(Continued)

(72) Inventors: **Tuomas Vallius**, Espoo (FI); **Jani Tervo**, Espoo (FI)

OTHER PUBLICATIONS

(73) Assignee: **MICROSOFT TECHNOLOGY LICENSING, LLC**, Redmond, WA (US)

Han, et al., "Portable Waveguide Display System with a Large Field of view by Integrating Freeform Elements and Volume Holograms", In Optics Express, vol. 23, Issue 3, Feb. 9, 2015, pp. 3534-3549.  
(Continued)

(\* ) Notice: Subject to any disclaimer, the term of this patent is extended or adjusted under 35 U.S.C. 154(b) by 0 days.

Primary Examiner — Loha Ben  
(74) Attorney, Agent, or Firm — Vierra Magen Marcus LLP

(21) Appl. No.: 15/097,661

(22) Filed: Apr. 13, 2016

(51) Int. Cl. G02B 27/14 (2006.01)  
G02B 27/44 (2006.01)  
(Continued)

(52) U.S. Cl. G02B 27/0172 (2013.01); G02B 5/1814 (2013.01); G02B 5/1819 (2013.01);  
CPC ..... G02B 27/0172 (2013.01); G02B 5/1814 (2013.01); G02B 5/1819 (2013.01);  
(Continued)

(58) Field of Classification Search CPC ..... G02B 5/18; G02B 5/1828; G02B 6/0011; G02B 6/0033; G02B 27/0101;  
(Continued)

(56) **References Cited**  
U.S. PATENT DOCUMENTS  
6,529,331 B2 3/2003 Masoff et al.  
6,563,648 B2 5/2003 Gleckman et al.  
(Continued)

(57) **ABSTRACT**  
An input-coupler of an optical waveguide couples light corresponding to the image and having a corresponding FOV into the optical waveguide, and the input-coupler splits the FOV of the image coupled into the optical waveguide into first and second portions by diffracting a portion of the light corresponding to the image in a first direction toward a first intermediate-component, and diffracting a portion of the light corresponding to the image in a second direction toward a second intermediate-component. An output-coupler of the waveguide combines the light corresponding to the first and second portions of the FOV, and couples the light corresponding to the combined first and second portions of the FOV out of the optical waveguide so that the light corresponding to the image and the combined first and second portions of the FOV is output from the optical waveguide. The intermediate-components and the output-coupler also provide for pupil expansion.

20 Claims, 5 Drawing Sheets

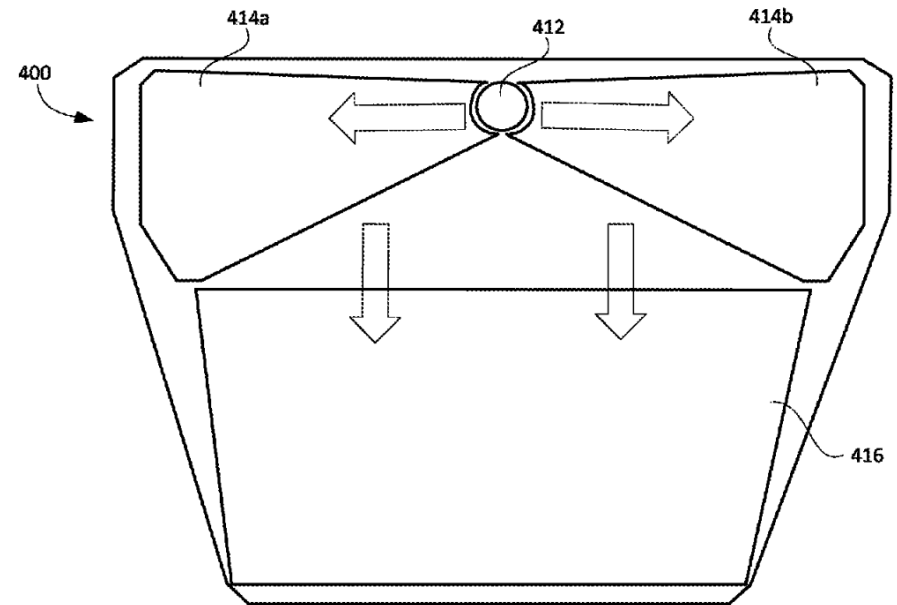
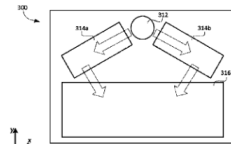
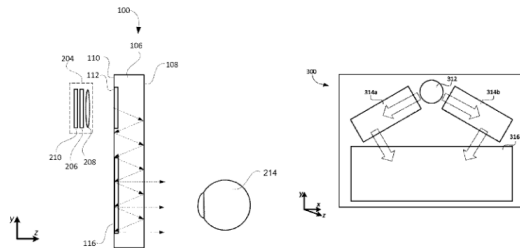

**FIG. 4**

# Task Description

## Source

- Plane Wave
- 532nm wavelength
- 1 mm × 1 mm diameter
- FOV 40° × 20°

## Eye Pupil Expander #1 (-20° – 0°)

- idealized grating
- 340nm period (1D)
- rotation (in x-y plane):  $\pm 35^\circ$
- diffraction efficiency:  
R1 = 10%, R0 = 90%

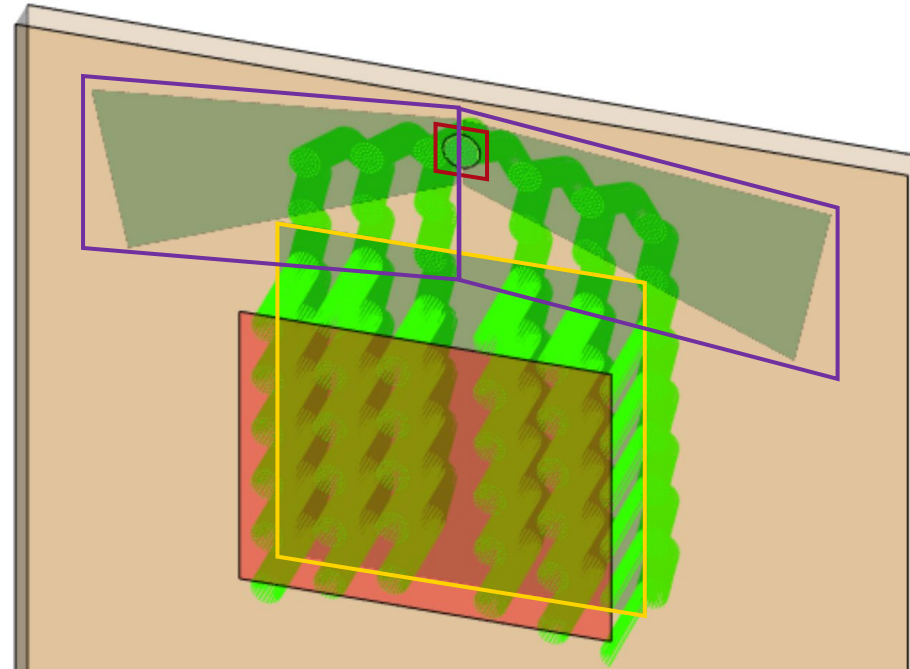

## Incoupler(s)

- idealized gratings (first and second surface)
- 400nm period (1D)
- rotation (in x-y plane):  $\pm 15^\circ$
- diffraction efficiency:  
T+1 = 10%, R-1 = 50%

## Eye Pupil Expander #2 (0° – 20°)

- idealized grating
- 340nm period (1D)
- rotation (in x-y plane):  $\pm 35^\circ$
- diffraction efficiency:  
R1 = 10%, R0 = 90%

## Outcoupler

- idealized grating
- 440nm period
- rotation (in x-y plane):  $-90^\circ$
- diffraction efficiency:  
T1 = 10%, R0 = 90%

# Light Guide Component

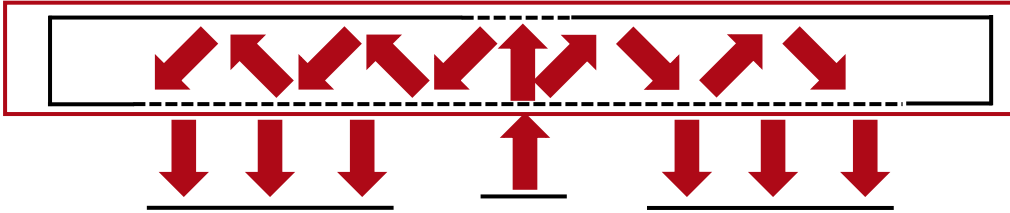

With the *Light Guide Component*, systems with regions with complex shapes can easily be defined. Furthermore, these regions can be equipped with idealized or real grating structures to act as incoupler, outcoupler or eye pupil expanders. More information under:

[Construction of a Light Guide](#)

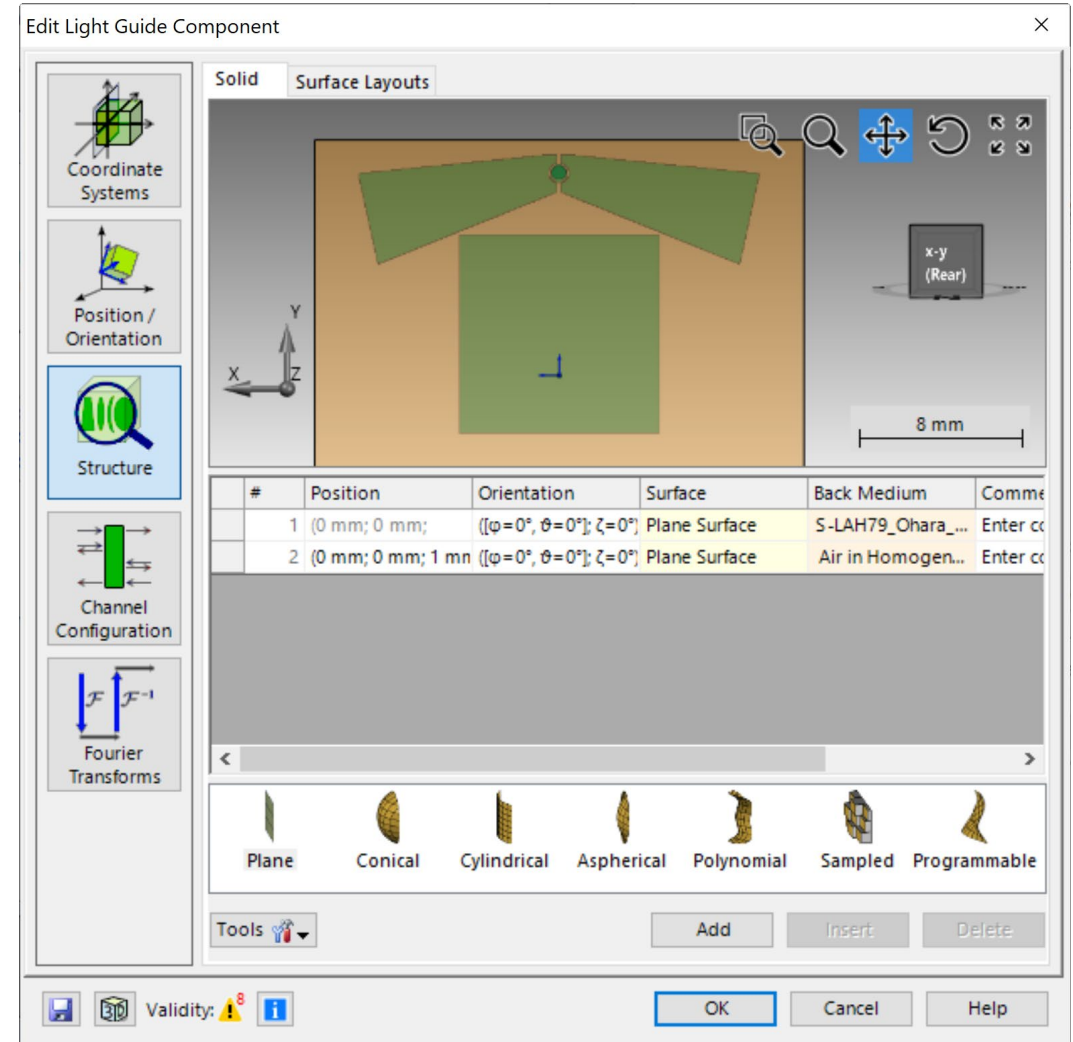

# Incoupling & Outcoupling Grating Regions

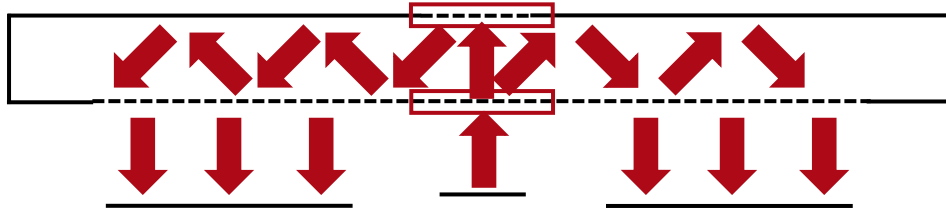

For the sake of simplicity, we use two 1D-periodic incoupler gratings (one on the first surface and one on the second one) in circularly shaped regions. This will lead to a slightly asymmetric behavior for the left and right part of the FOV, but it is possible to overcome this by combining both gratings into a single 2D-periodic structure (located either on the first or second surface).

In order to recombine and outcouple the light, a 1D-periodic outcoupler is applied, with a rectangular shaped region. This is a specific configuration and to allow for further flexibility in the design it is possible to exchange it by a 2D-periodic outcoupler instead.

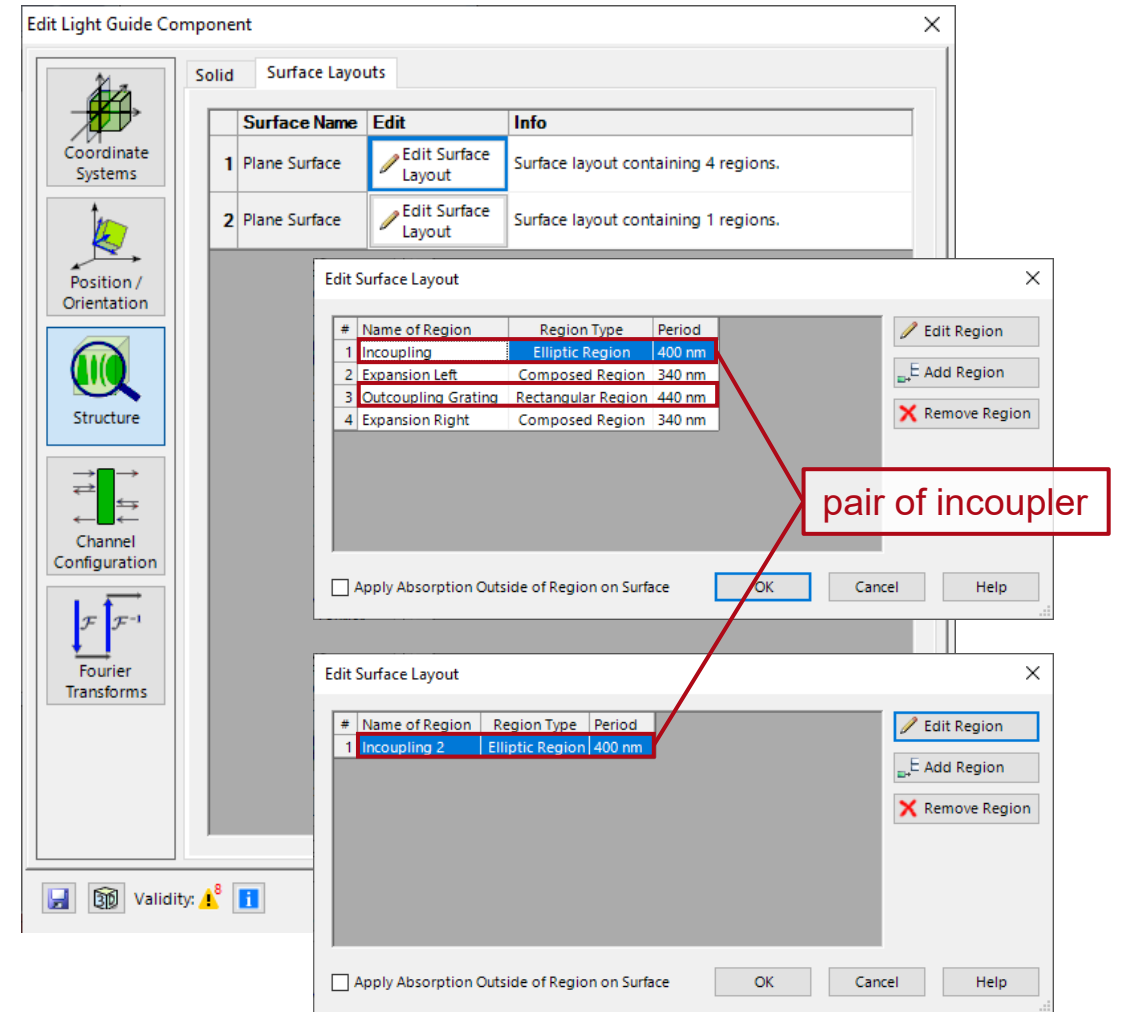

# Eye-Pupil-Expander (EPE) Region

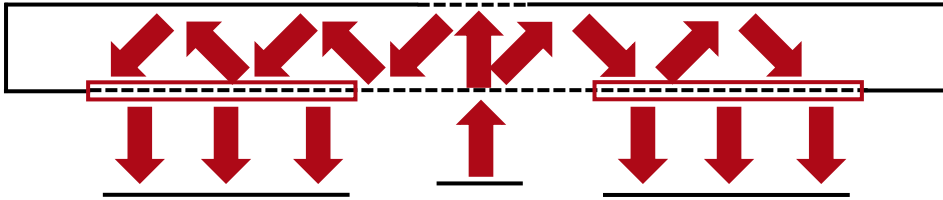

The shape of each region can be defined very flexibly using different approaches and definition strategies. In this example, both EPEs are defined by polygonal regions in combination with two ellipsoids to cut the inner part. The gratings are 1D-periodic and rotated by  $\pm 35^\circ$  (for left and right respectively). More information about region definition under:

 [Flexible Region Configuration](#)

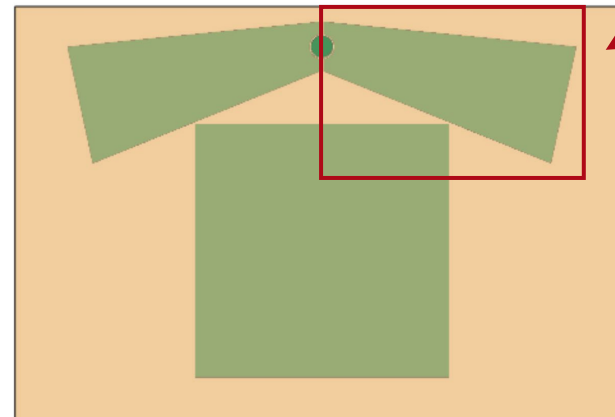
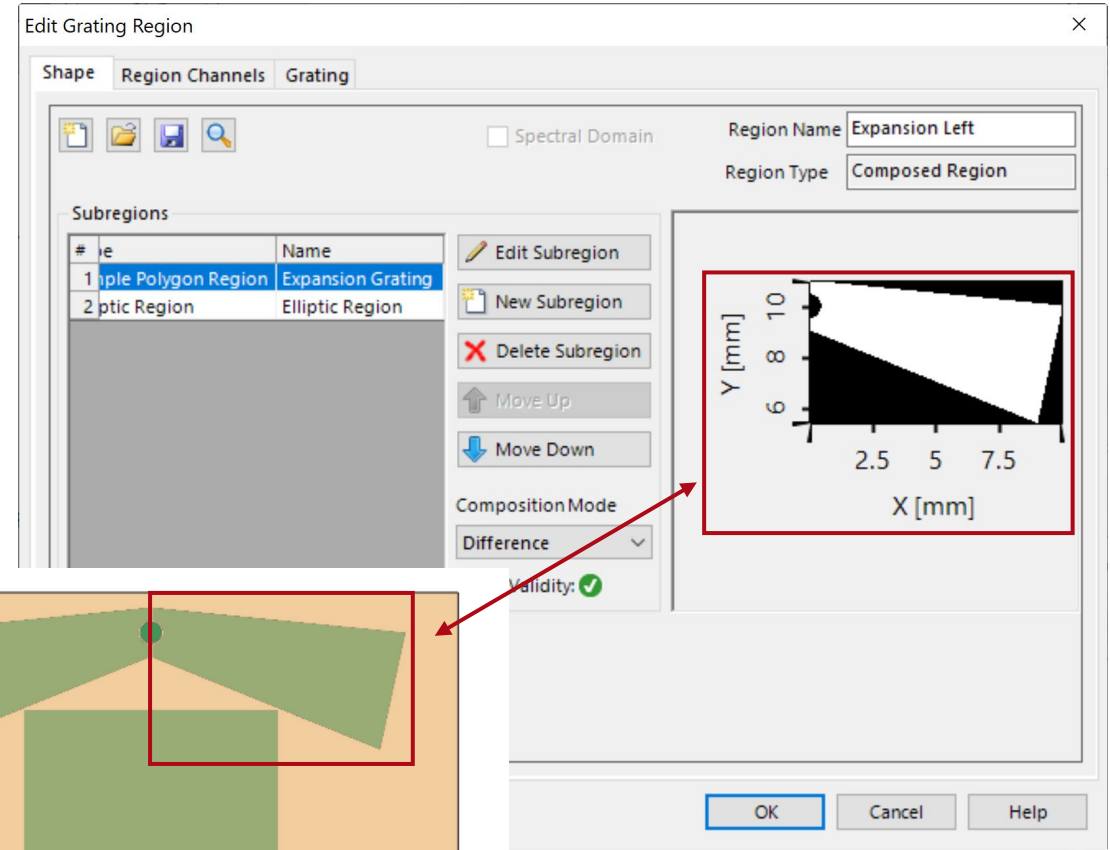



# Design & Analysis Tools

VirtualLab Fusion provides a series of tools to help the optical engineer in the task of designing and analyzing lightguide systems, including:

- **Lightguide Layout Design Tool:**  
Design a lightguide with 1D-1D pupil expansion, which can serve as the basis of your system.

[!\[\]\(666e09182d4cd268646ea700ea60dcdf\_img.jpg\) Light Guide Layout Design Tool](#)

- **k-Domain Layout Tool:**  
Analyze coupling conditions of your design.

[!\[\]\(d66ff64371a51729ac8c1cdaa685ba6f\_img.jpg\) k-Domain Layout Visualization](#)

- **Footprint & Grating Analysis Tool:**  
Detect the footprints in your system to determine the size and shape of your regions.

[!\[\]\(003082e50e3009141f59bd5df831749f\_img.jpg\) Footprint Analysis of Lightguides for AR/MR Applications](#)

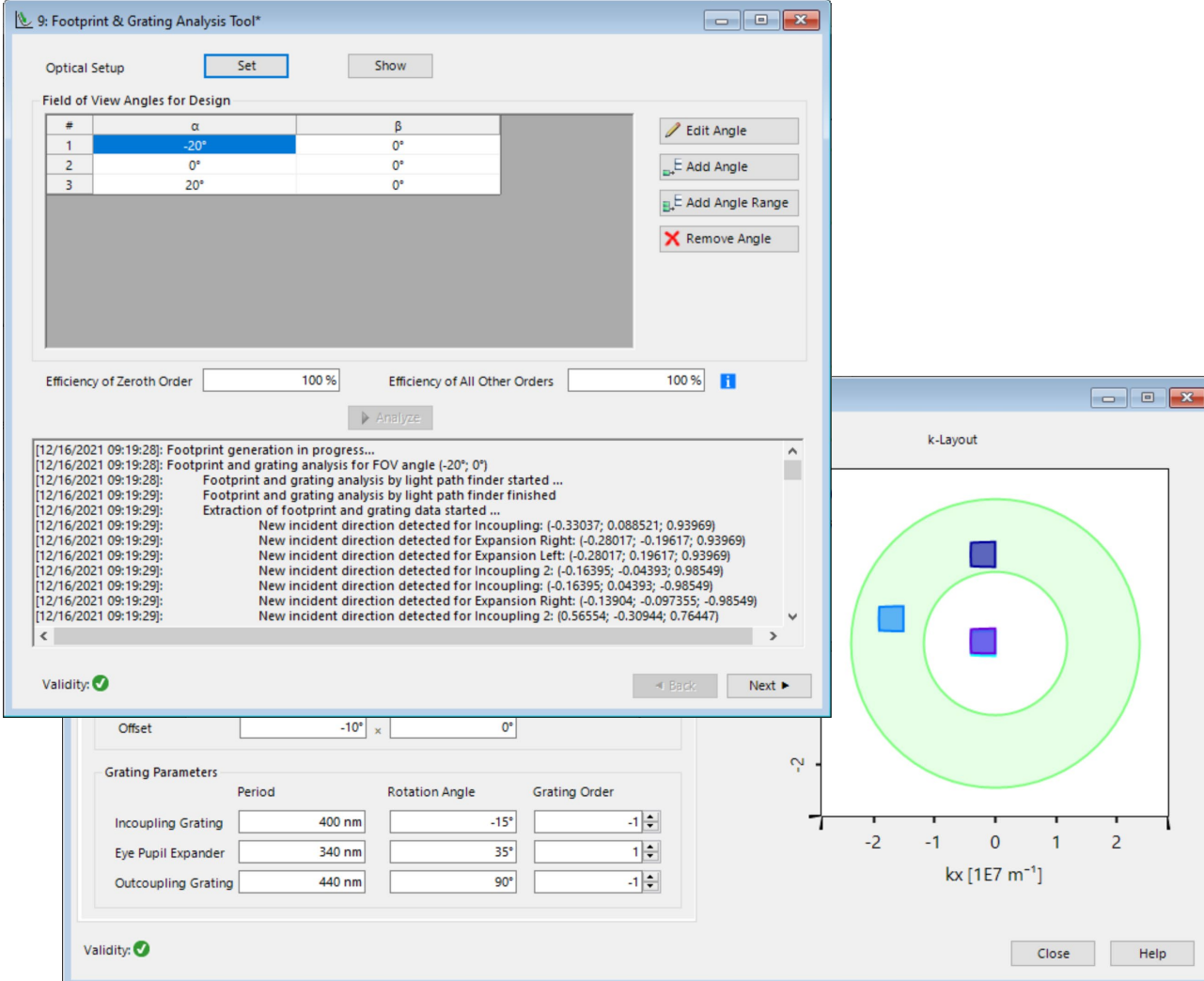

#	$\alpha$	$\beta$
1	-20°	0°
2	0°	0°
3	20°	0°

Efficiency of Zeroth Order: 100%    Efficiency of All Other Orders: 100%

Validity: 

Grating Parameters:

	Period	Rotation Angle	Grating Order
Incoupling Grating	400 nm	-15°	-1
Eye Pupil Expander	340 nm	35°	1
Outcoupling Grating	440 nm	90°	-1



# Summary – Components...

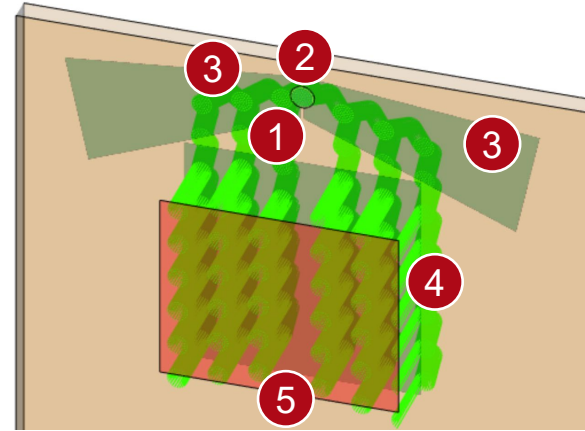
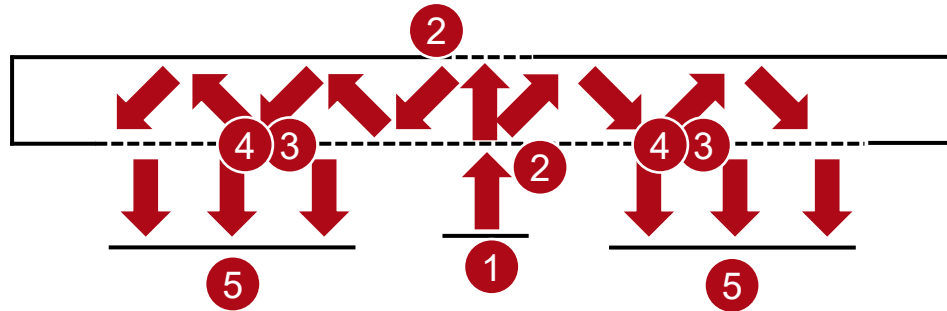

... of Optical System	... in VirtualLab Fusion	Model/Solver/Detected Value
1. Source	<i>Scanning Source</i>	Truncated ideal plane waves with different incident angle
2. Incoupler	Idealized grating in <i>Rectangular Region</i>	Idealized Rayleigh matrices
3. Eye Pupil Expansion	Idealized grating in <i>Polygonal Region</i>	Idealized Rayleigh matrices
4. Outcoupler	Idealized grating in <i>Rectangular Region</i>	Idealized Rayleigh matrices
5. Eye	<i>Camera Detector</i>	Energy density measurement

# Result: Rays in System

only light hitting the “eye-box” (camera detector):

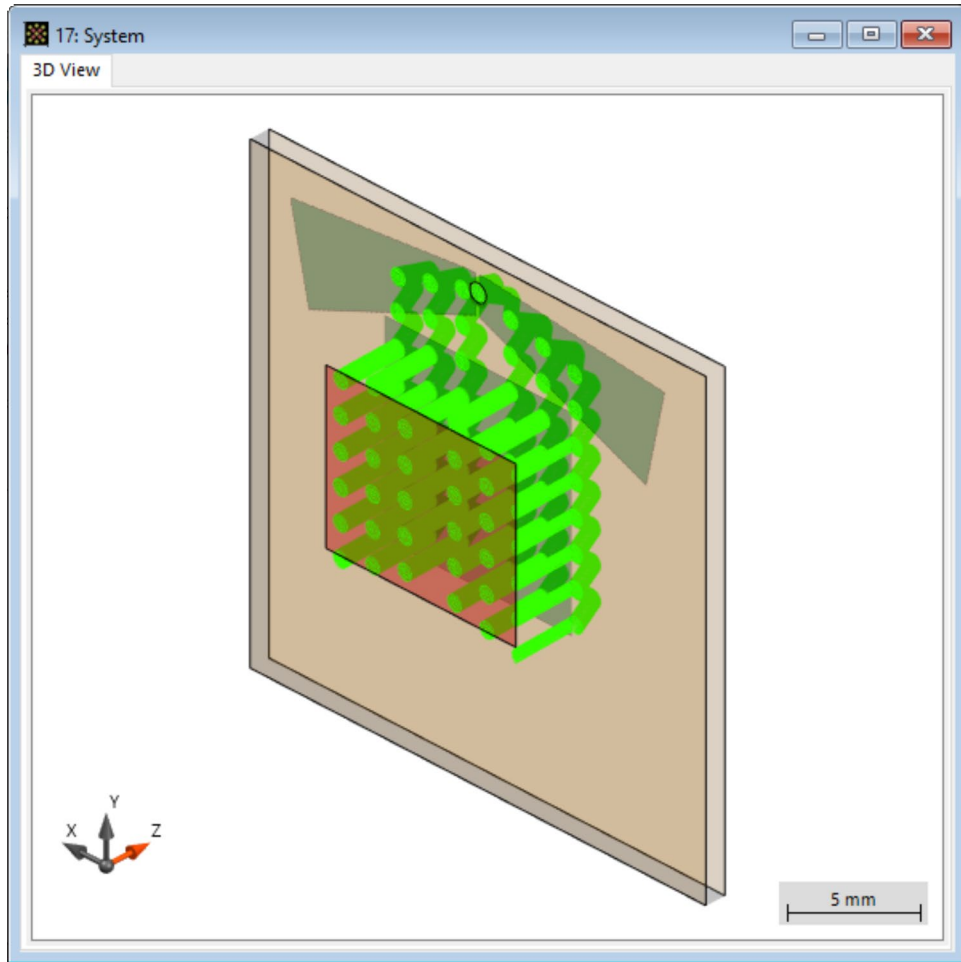

all light propagating inside the light guide:

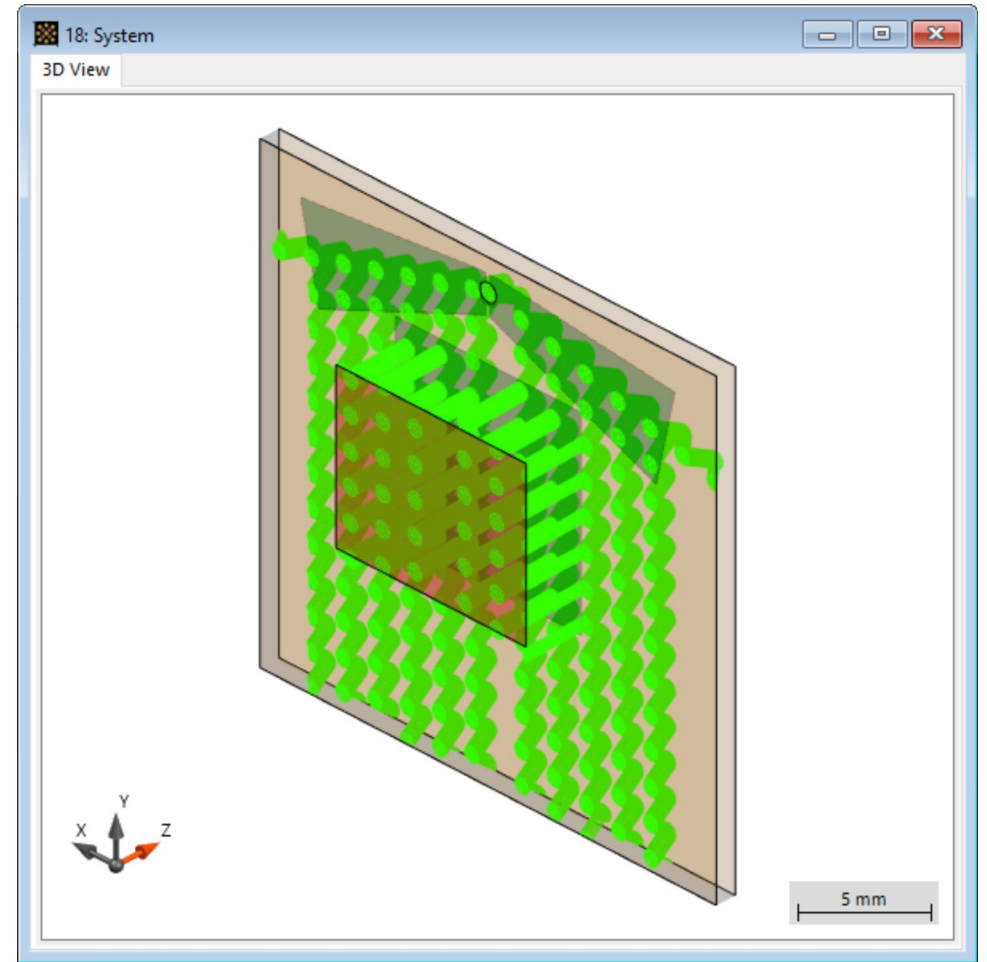

# FOV: 0° × 0°

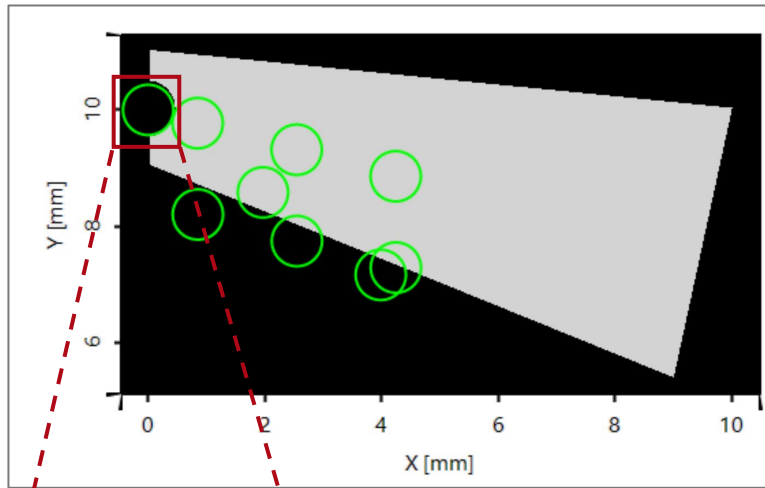
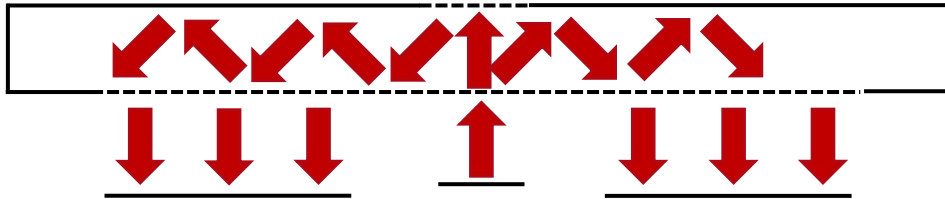

Slightly asymmetric light distribution, because of the two incouplers (first and second surface).

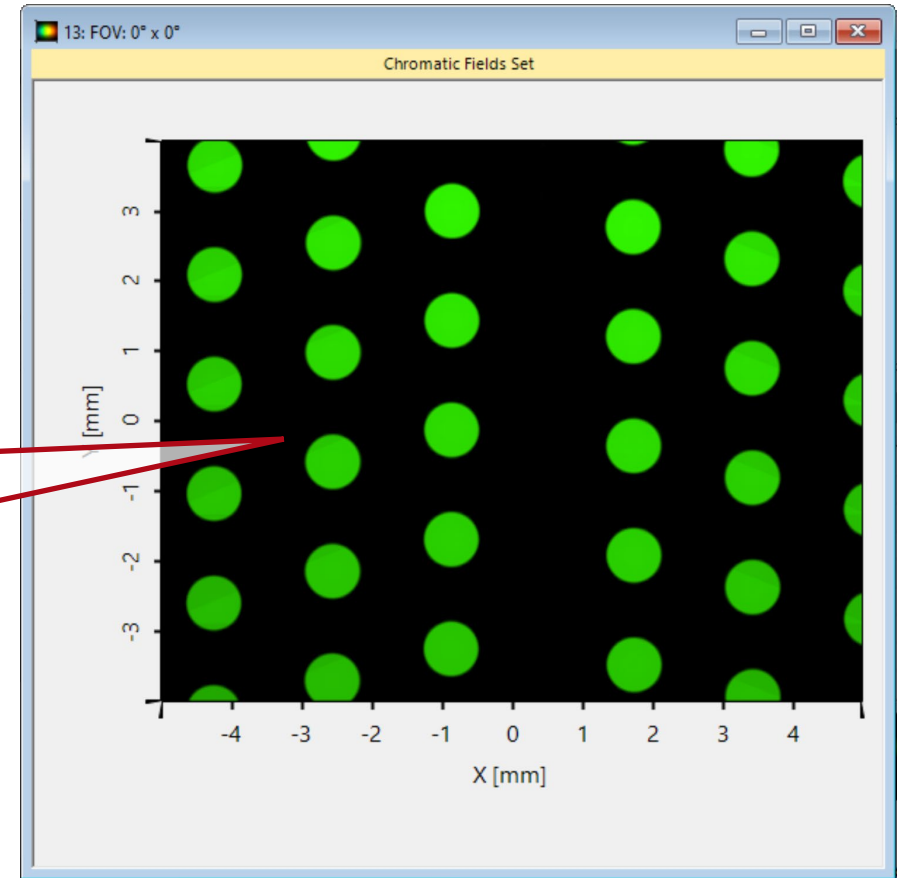
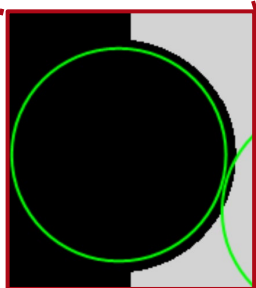
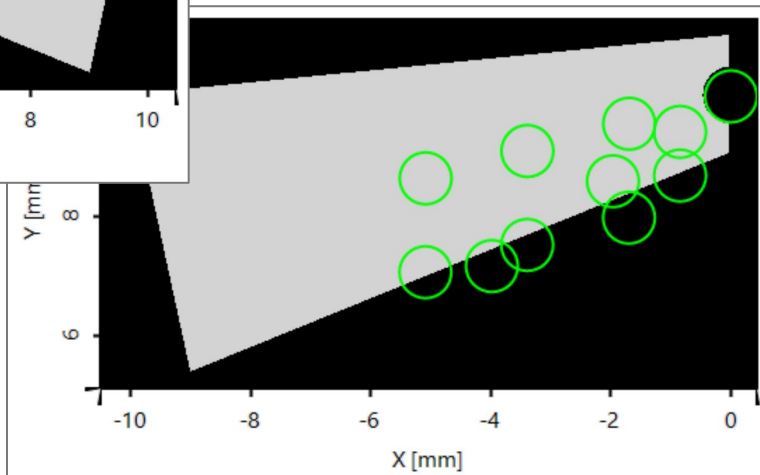

**Note:** The footprint display refers to the coordinate system (CS) of the region's surface. Their visualization is therefore mirrored.

# FOV: $-20^\circ \times 0^\circ$

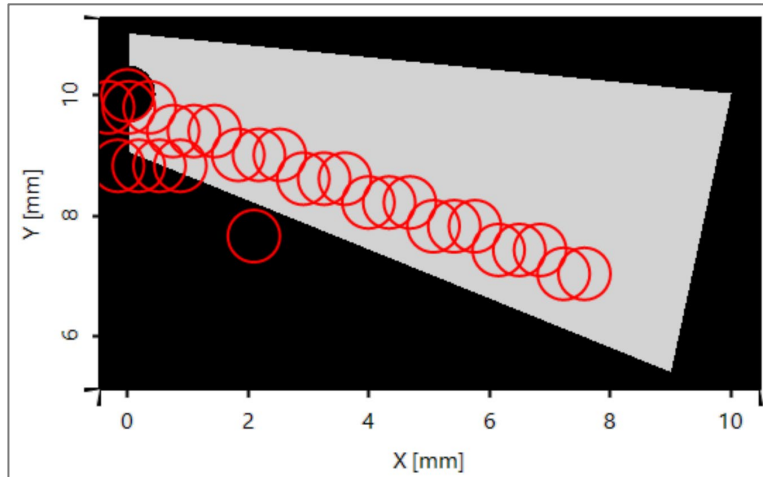
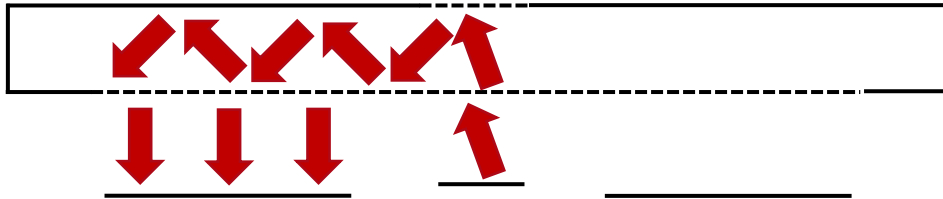

Aperture effects are introduced by multiple interactions due to the inclined impinging beam.

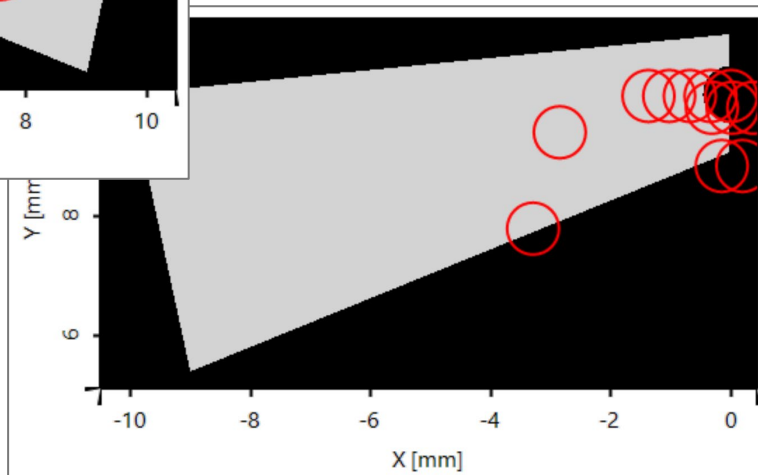

**Note:** The footprint display refers to the coordinate system (CS) of the region's surface. Their visualization is therefore mirrored.

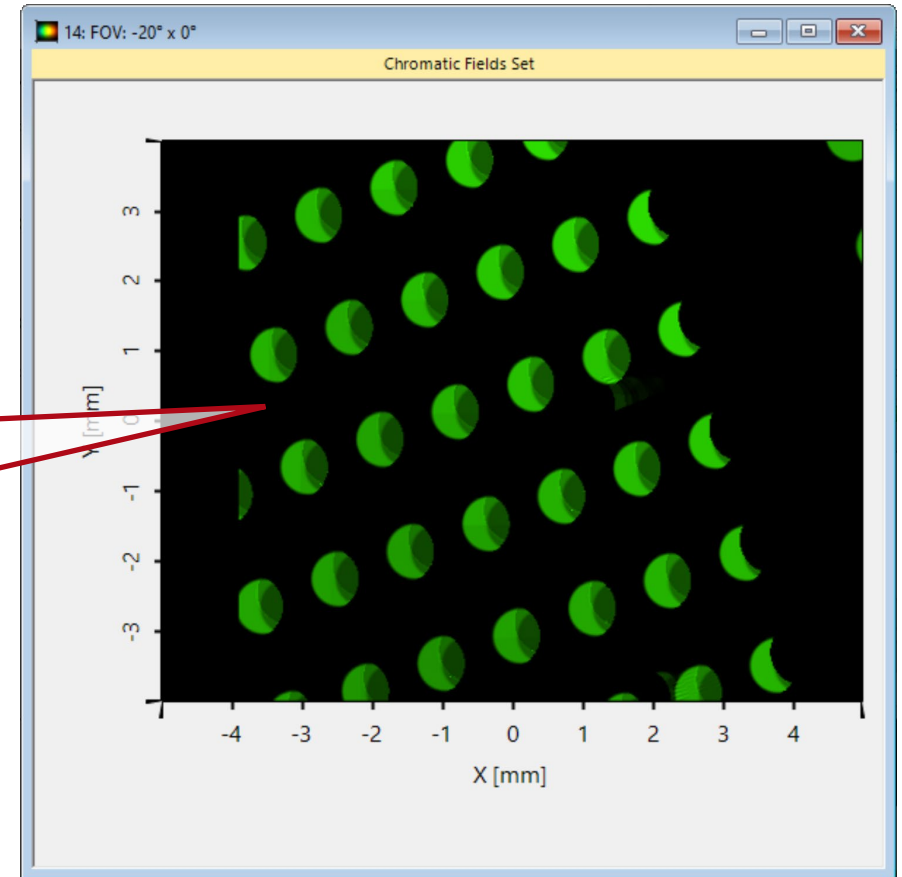

# FOV: 20° × 0°

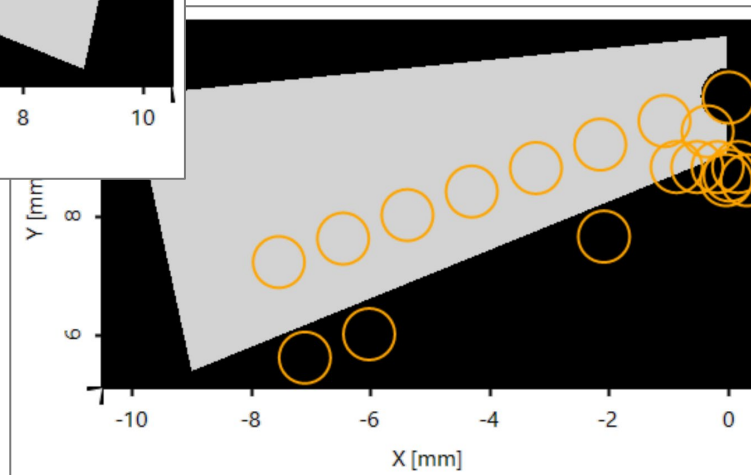
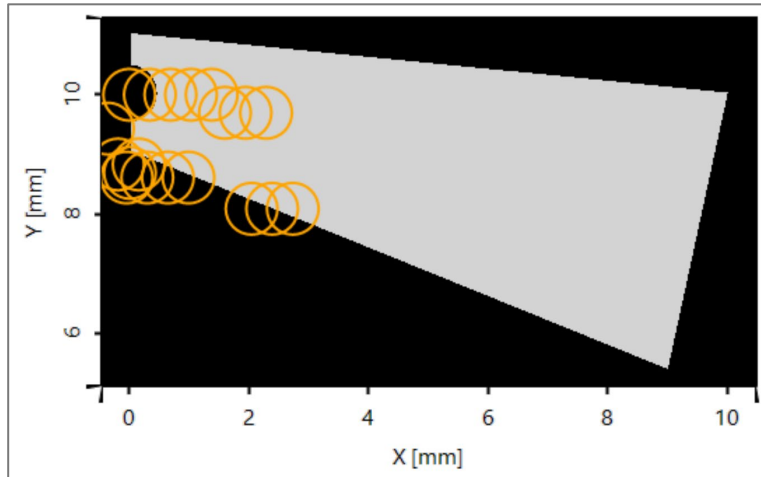
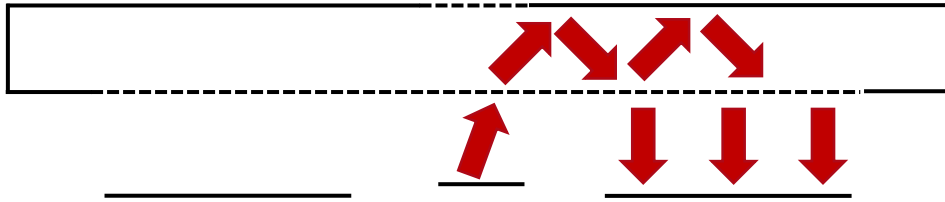

The nonsequential model can also be used to evaluate undesired effects generated by multiple grating interactions.

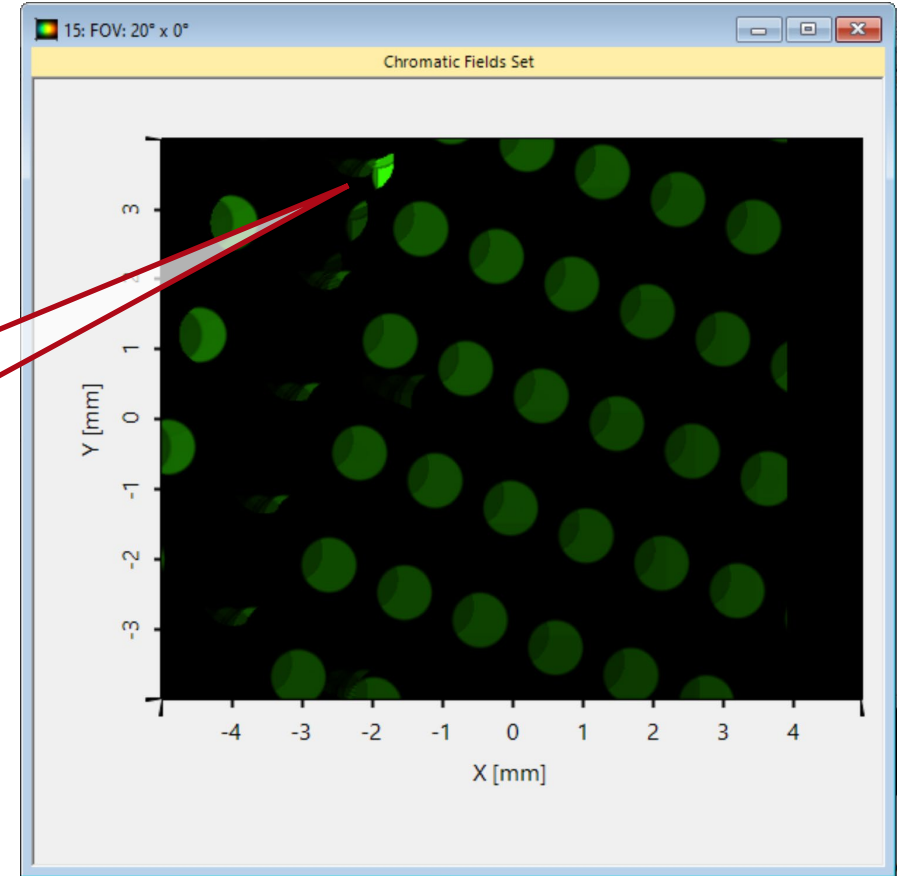

**Note:** The footprint display refers to the coordinate system (CS) of the region's surface. Their visualization is therefore mirrored.

# VirtualLab Fusion Technologies

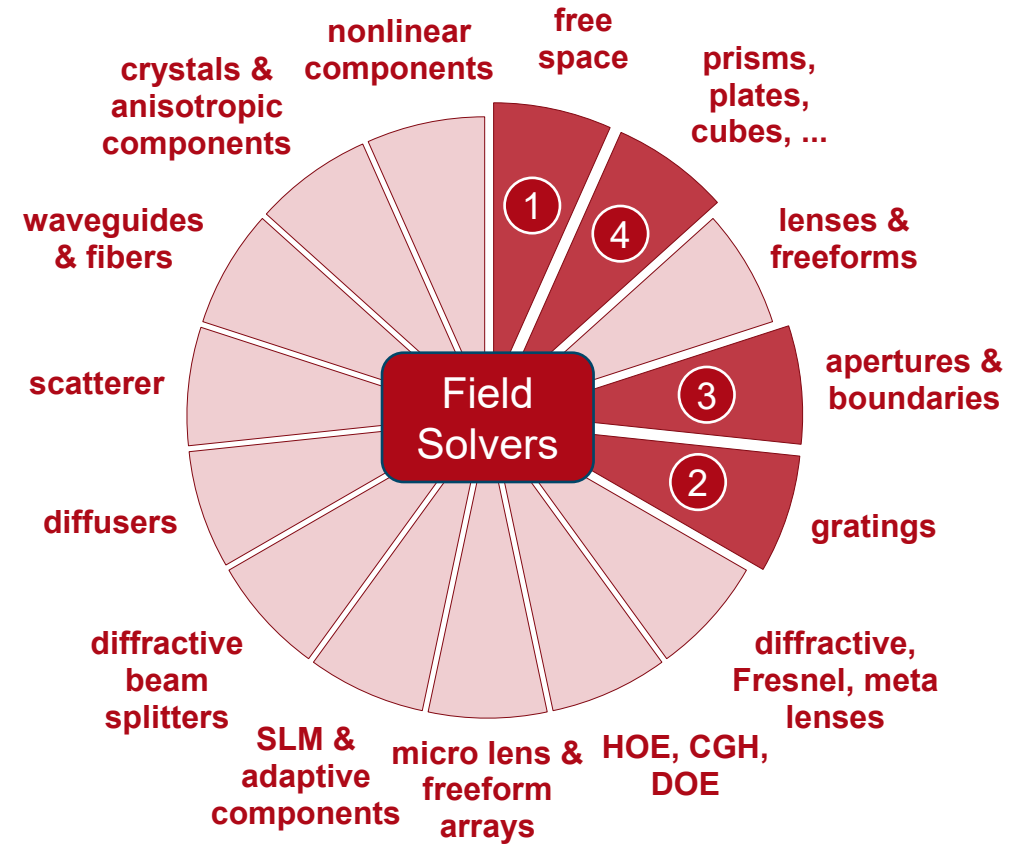
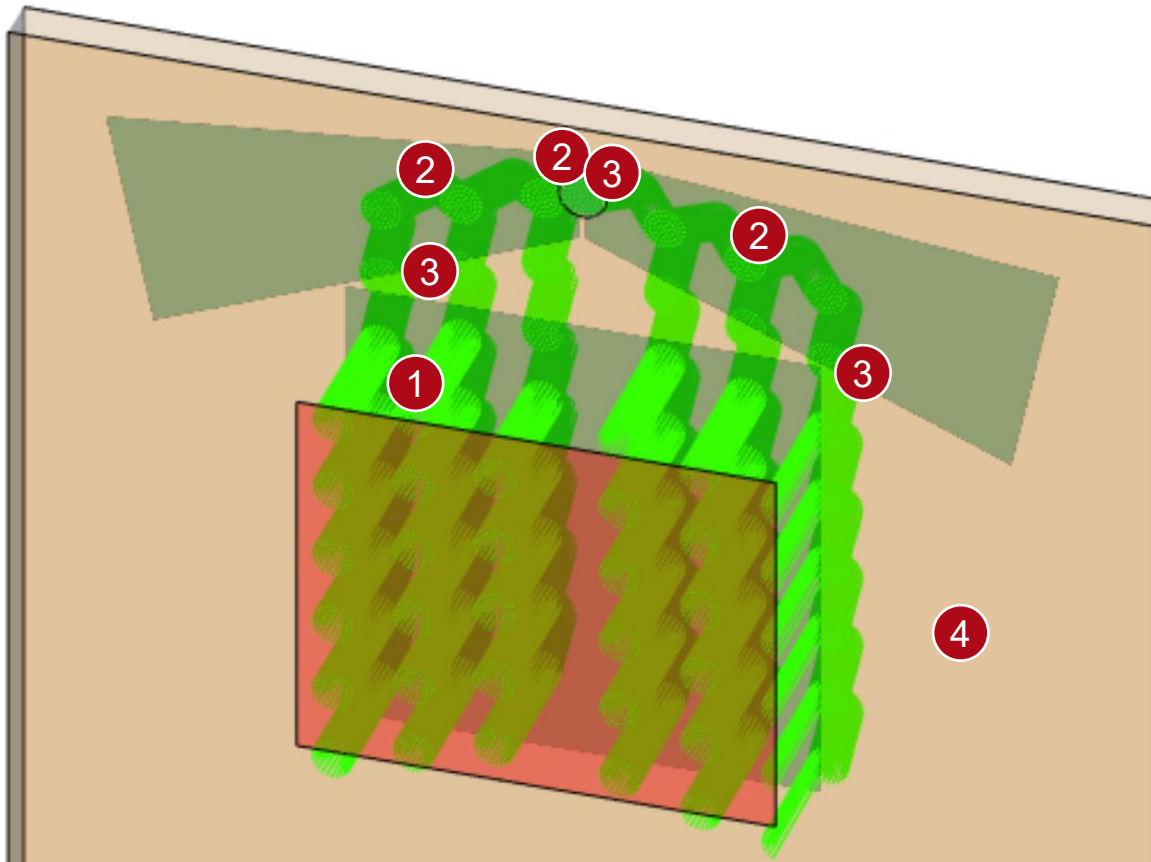

# Document Information

title	Lightguide with Butterfly Eye-Pupil Expander based on Patent by Microsoft
document code	LIG.0012
document version	1.0
software version	2021.1 (Build 1.180)
software edition	<ul style="list-style-type: none"><li>• VirtualLab Fusion Advanced</li><li>• Light Guide Toolbox Silver Edition</li></ul>
category	Application Use Case
further reading	<ul style="list-style-type: none"><li>- <a href="#"><u>Construction of a Light Guide</u></a></li><li>- <a href="#"><u>Light Guide Layout Design Tool</u></a></li><li>- <a href="#"><u>Flexible Region Configuration</u></a></li><li>- <a href="#"><u>k-Domain Layout Visualization</u></a></li><li>- <a href="#"><u>Footprint Analysis of Lightguides for AR/MR Applications</u></a></li><li>- <a href="#"><u>Lightguide with 2D-periodic Grating Structures (diamond-shaped) based on Patent by Wave Optics</u></a></li></ul>