

# Advanced PSF Calculation in a High-NA Lens System

# Abstract

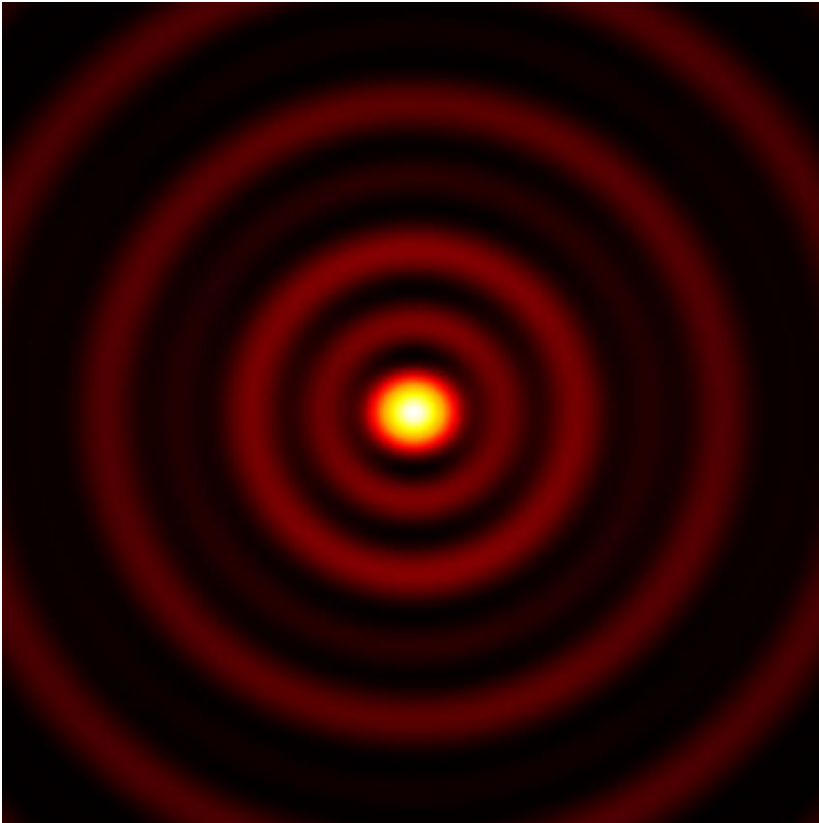

It is known that the vectorial nature of light plays a non-negligible role in high-NA focusing situations. In this example, focusing of a linearly polarized Gaussian beam by a high-NA aspheric lens is presented, and the asymmetric PSF in the focal plane is shown. By examining the electromagnetic field components in the focal plane, it can be found that the asymmetry is caused by a relatively strong  $E_z$  component.

# Modeling Task

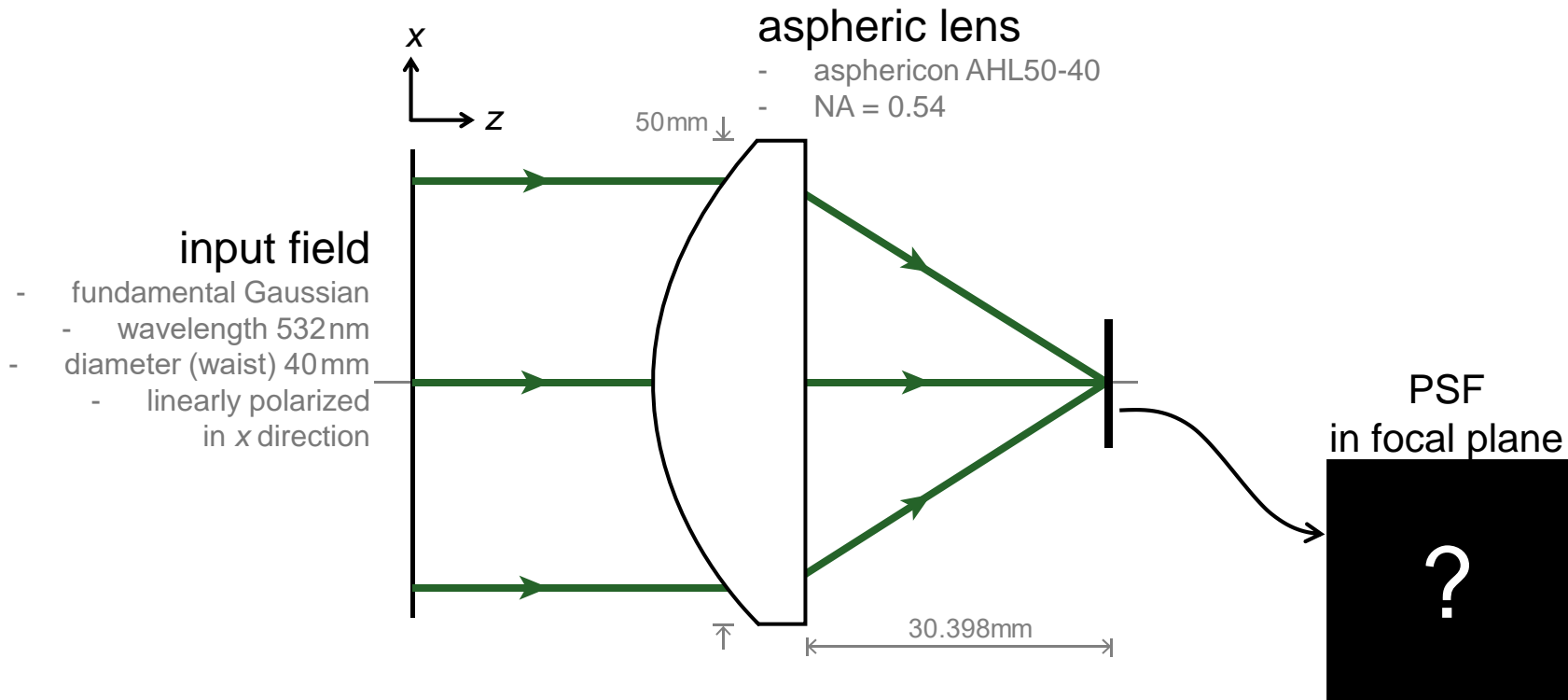

# Results

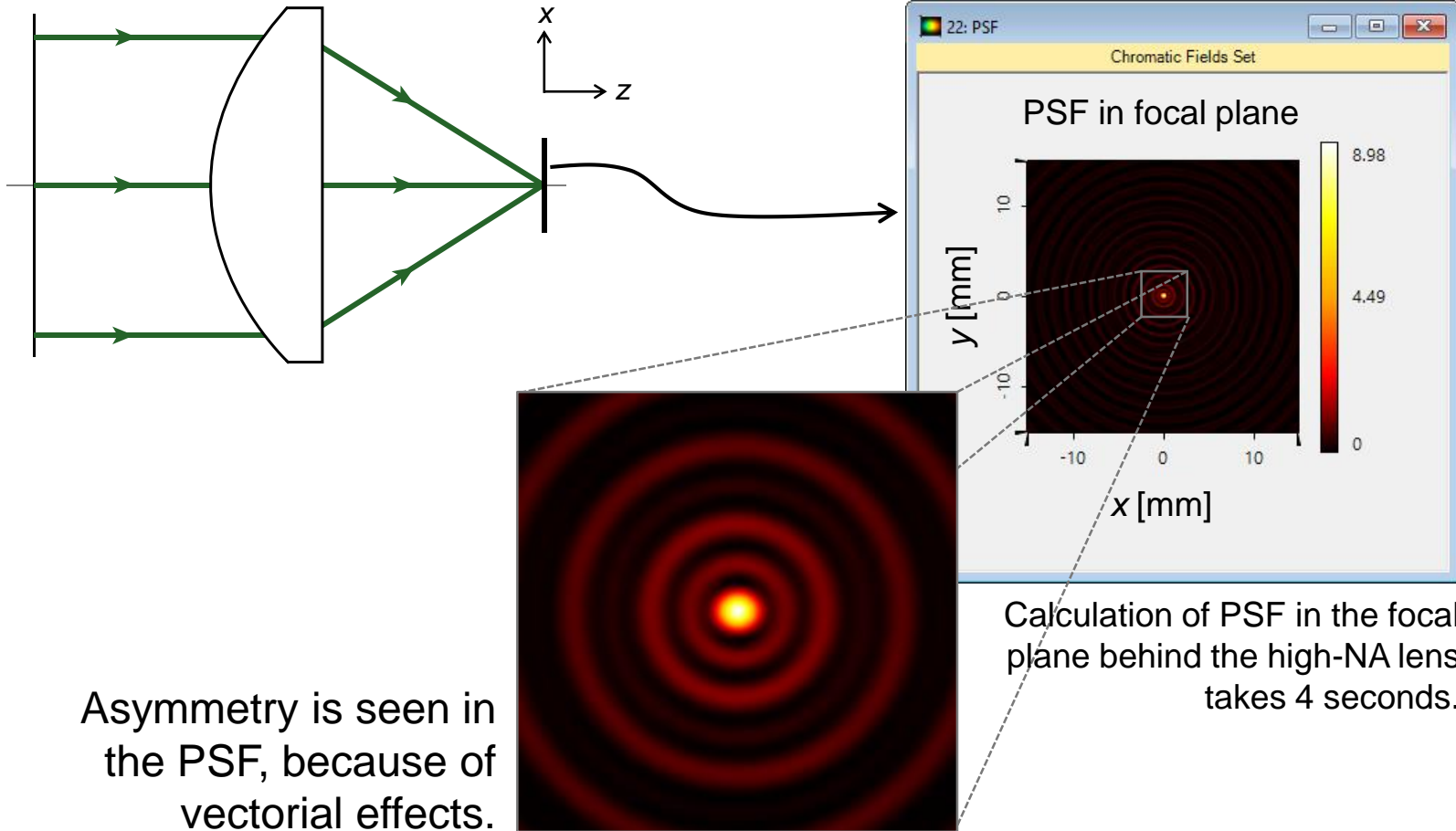

# Results

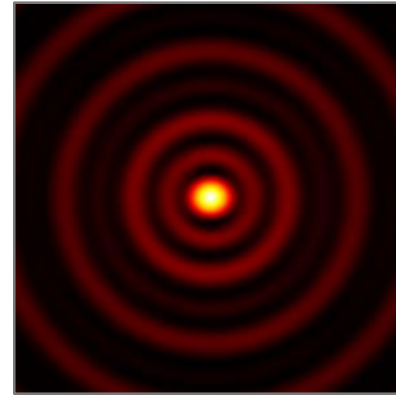
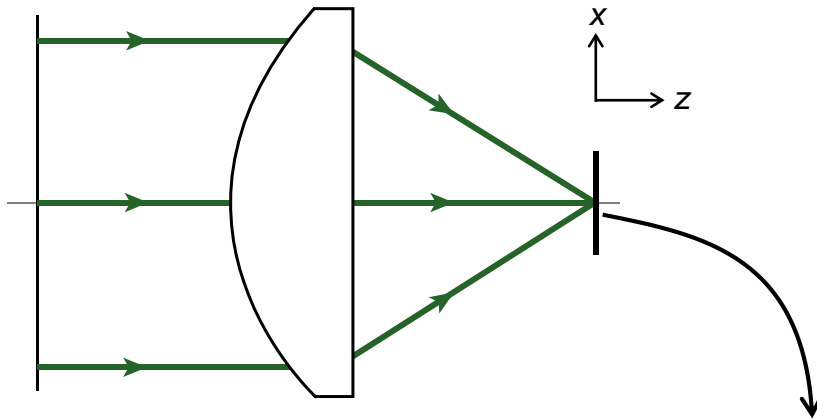

Asymmetry in PSF is due to the relatively strong  $E_z$  component.

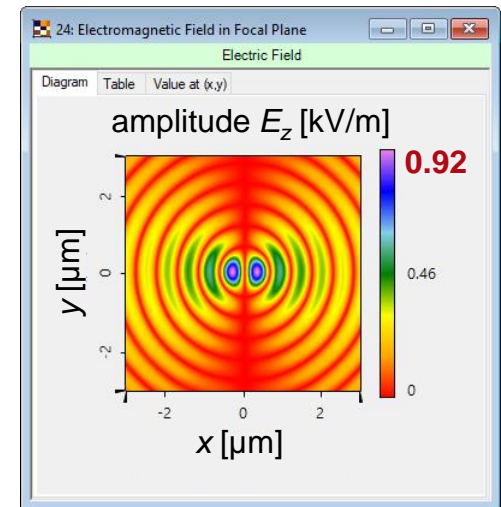
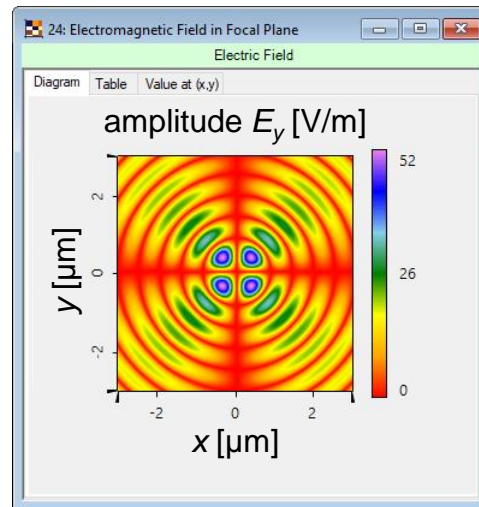
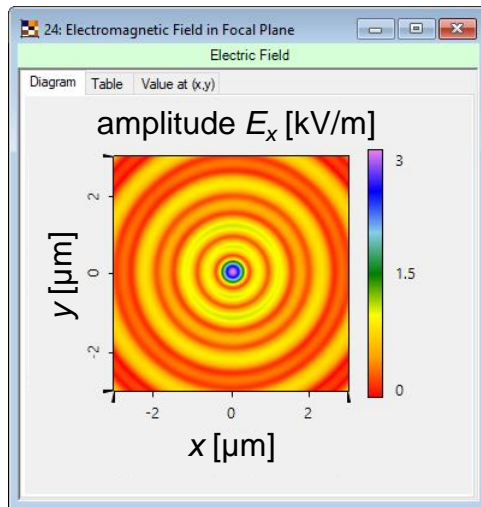

# Document Information

---

title	Advanced PSF Calculation in a High-NA Lens System
version	1.1
VL version used for simulations	7.4.0.45
category	Application Use Case

---